

Stand 1001

Fits almost all mailboxes

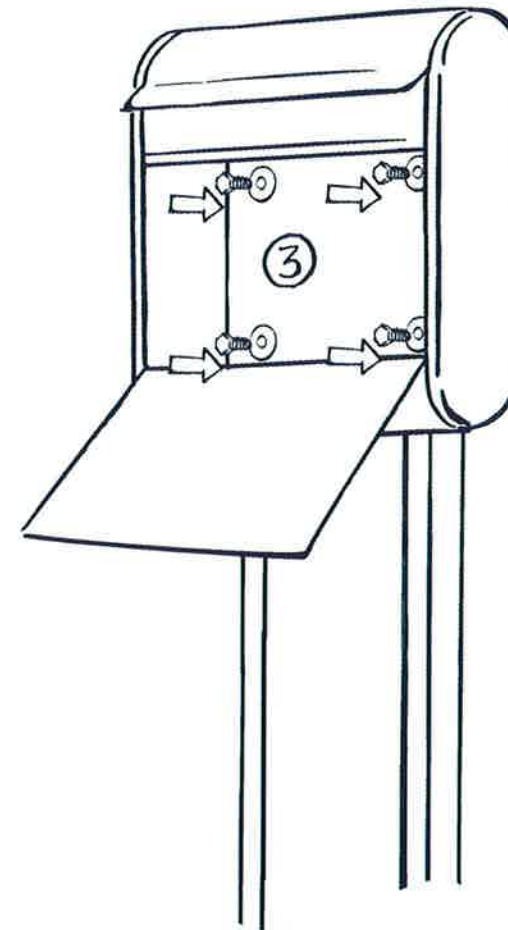

We recommend that you mount the mailbox on the stand before burying/casting it

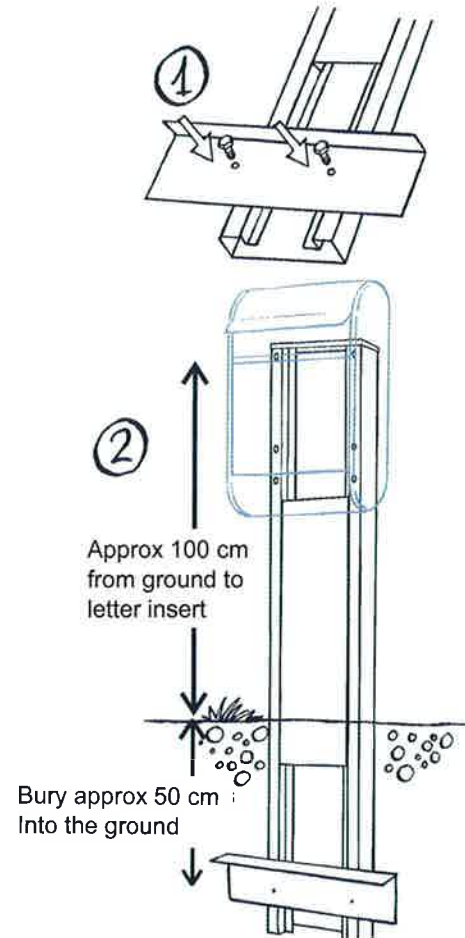
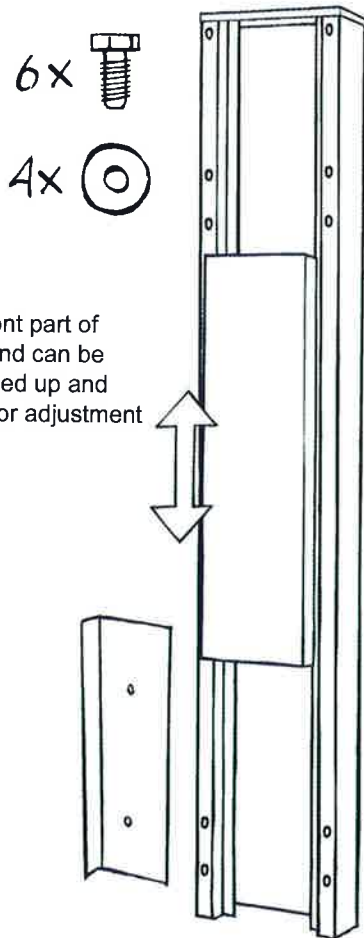

Template for drilling new mounting holes in the mailbox. Hole: Ø6 mm

